



VinilForte

PISOS VINÍLICOS E RODAPÉS

2024

CARMELO FIOR **35**
ANOS

#OqueridinhoDoBrasil

Descubra a essência da **VinilForte** pisos vinílicos e rodapés, em que inovação, sofisticação e personalização se unem para criar ambientes únicos, moldados de acordo com o seu estilo de vida.

Produzidos no Brasil, os produtos da **VinilForte** são sinônimos de qualidade e sustentabilidade.

Nossos itens oferecem a combinação perfeita entre inovação e conforto, proporcionando espaços que refletem não apenas as últimas tendências, mas também o bem-estar.

#ElfavoritodeBrasil

Descubra la esencia de VinilForte pisos vinílicos y zócalos, donde la innovación, sofisticación y personalización se unen para crear ambientes únicos, adaptados a su estilo de vida.

Producidos en Brasil, los productos de VinilForte son sinónimo de calidad y sostenibilidad.

Nuestros artículos ofrecen la combinación perfecta entre innovación y confort, proporcionando espacios que reflejan no sólo las últimas tendencias, sino también bienestar.

#ThefavoritefromBrazil

Discover the essence of VinilForte vinyl tiles and skirting, where innovation, sophistication and customization unite to create unique ambiances, molded according to your lifestyle.

Produced in Brazil, VinilForte products are synonymous with quality and sustainability.

Our items offer the perfect combination of innovation and comfort, providing spaces that reflect not only the latest trends, but also wellbeing.



Produto nacional
Hecho en Brasil
Made in Brazil



Proteção UV
Protección UV
UV protection



Rápida instalação
Instalación rápida
Quick installation



Conforto acústico
Comodidad acústica
Acoustic comfort



Produto reciclável
Producto reciclable
Recyclable product



Desenho em alta definição
Dibujo de alta definición
High definition drawing



Conforto térmico
Comodidad térmica
Thermal comfort



Fácil de limpar
Fácil de limpiar
Easy to clean



Hipoalergênico
Hipoalergénico
Hypoallergenic



Ideal para pet
Ideal para mascota
Pet friendly



Resistente a cupins
Resistente a las termitas
Termite resistant



10 anos de garantia residencial
10 años de garantía residencial
10 years residential warranty



Maior resistência
Mayor resistencia
Greater resistance



5 anos de garantia comercial e industrial
5 años de garantía comercial e industrial
5 years commercial and industrial warranty



Pinus 19x123cm | 3'x4'8"

Natural Leve

Natural Leve | Light Natural

24x150cm

9"x59"



LOCAL DE USO LOCAL DE USO USAGE	ESPESSURA ESPESOR THICKNESS	CAPA PROTETIVA CAPA PROTECTORA PROTECTIVE LAYER	VARIAÇÃO DE TONALIDADE VARIACION DE TONALIDAD SHADE VARIATION
Residencial* Residencial* Residencial*	2mm 0.08"	0,2mm 0.008"	V5-Aleatória V5-Aleatoria V5-Random

*Consulte tabela de 'local de uso' nas páginas 24 e 25.

*Consulte la tabla de 'local de uso' en las páginas 24 e 25.

*See 'usage' chart on pages 24 e 25.

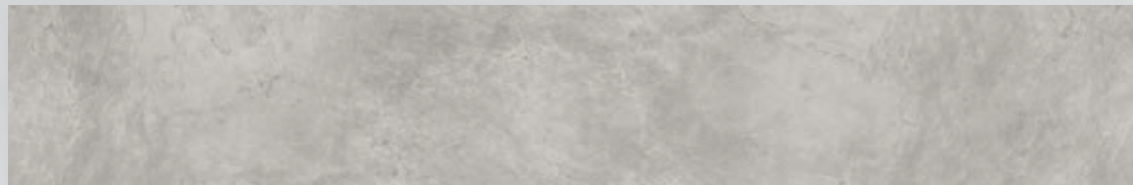

GRANADA

8322002

24x150cm - 9"x59"

VELVET



ACÁCIA

8322000

24x150cm - 9"x59"

RELEVO



PINUS

8322003

24x150cm - 9"x59"

RELEVO



CARVALHO

8322005

24x150cm - 9"x59"

RELEVO

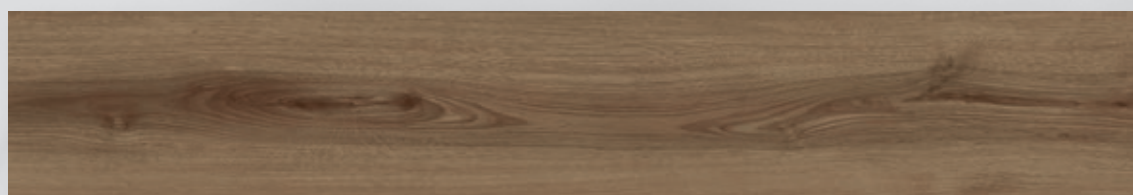

OLIVEIRA

8322004

24x150cm - 9"x59"

RELEVO

Natural Leve

Natural Leve | Light Natural

24x150cm

9"x59"

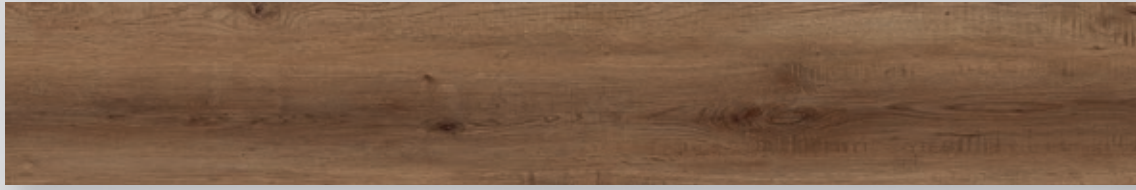

PITANGUEIRA

8322006

24x150cm - 9"x59"

RELEVO



TIMBÓ

8322001

24x150cm - 9"x59"

RELEVO



Timbó 24x150cm | 9"x59"

Rodapé de poliestireno

Zócalo de poliestireno | Polystyrene skirting

O ACABAMENTO PERFEITO!

O rodapé é um complemento essencial que oferece diversos benefícios, tornando-se o acabamento perfeito para diversos ambientes. Uma das principais vantagens é a sua rápida instalação, o que proporciona praticidade e agilidade no processo de revestimento do espaço.

¡El acabado perfecto!

El zócalo es un complemento imprescindible que ofrece múltiples ventajas, convirtiéndolo en el acabado perfecto para diversos ambientes. Una de las principales ventajas es su rápida instalación, proporcionando practicidad y agilidad en el proceso de revestimiento del espacio.

The perfect finishing!

The skirting is an essential complement that offers several benefits, turning it into the perfect finishing for any ambience. One of the most main advantages is its quick installation, providing practicality and agility in the process of coating of spaces.



Produto nacional
Hecho en Brasil
Made in Brazil



Resistência à água
Resistente al agua
Water resistance



Pronto para instalar
Listo para instalar
Ready to install



Rápida instalação
Instalación rápida
Quick installation



Fácil de limpar e conservar
Fácil de limpiar y mantener
Easy to clean and maintain



Ecologicamente correto
Ecológicamente correcto
Ecologically correct



Resistência a cupins e insetos
Resistencia a termitas e insectos
Resistance to termites and insects



5 anos de garantia
5 años de garantía
5 years warranty

NOVA ESPESSURA

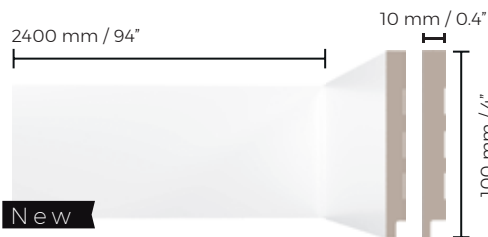

BRANCO LISO 10

8910010

Blanco liso 10 / White flat 4"



BRANCO FRISADO 10

8910110

Blanco ranurado 10 / White groove 4"



BRANCO LISO 7

8907010

Blanco liso 7 / White flat 3"

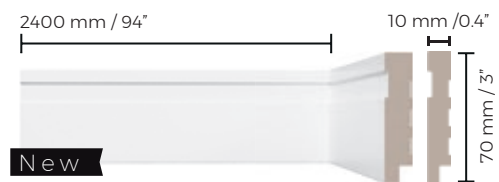

BRANCO FRISADO 7

8907110

Blanco ranurado 7 / White groove 3"

Rodapé de poliestireno

Zócalo de poliestireno | Polystyrene skirting

LOCAL DE USO
LOCAL DE USO
USAGE

Exclusivo para uso
em ambientes internos
Interior exclusive / Indoor use only



Função passa-fios
Función de paso de cable
Wire pass-underneath function

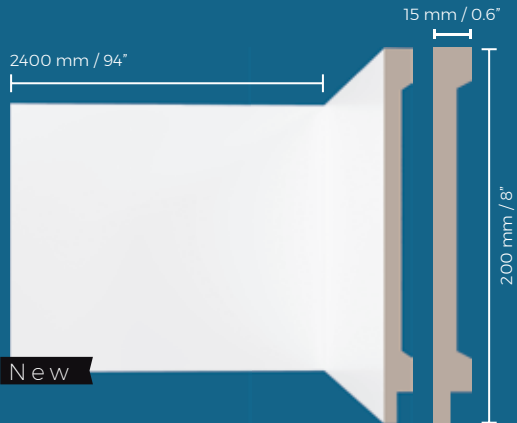

BRANCO LISO 20

8920000
Blanco liso 20 / White flat 8"

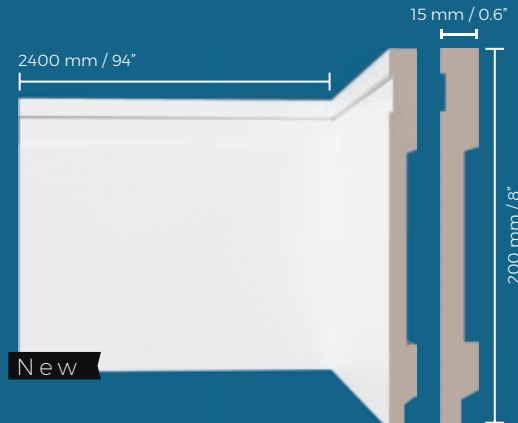

BRANCO FRISADO 20

8920100
Blanco ranurado 20 / White groove 8"

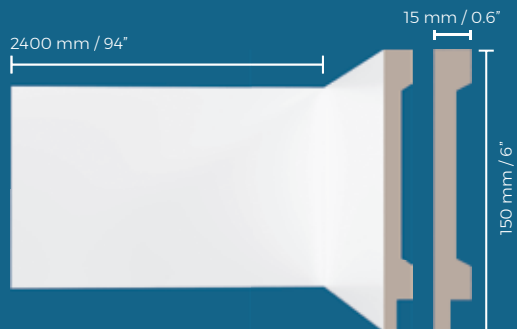

BRANCO LISO 15

8915000
Blanco liso 15 / White flat 6"

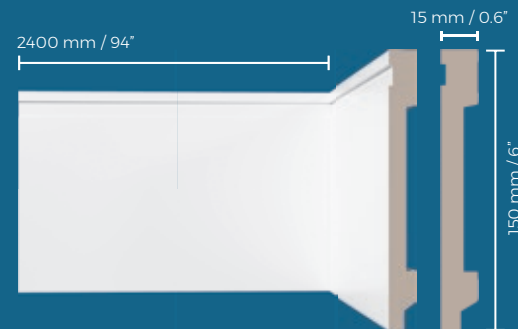

BRANCO FRISADO 15

8915100
Blanco liso 15 / White flat 6"

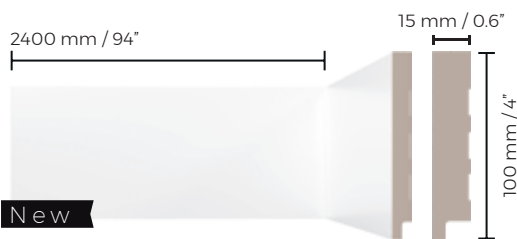

BRANCO LISO 10

8910000
Blanco liso 10 / White flat 4"



BRANCO FRISADO 10

8910100
Blanco ranurado 10 / White groove 4"



BRANCO LISO 7

8907000
Blanco liso 7 / White flat 3"



BRANCO FRISADO 7

8907100
Blanco ranurado 7 / White groove 3"

Essencial Ultra

Essencial Ultra | Ultra Essential

96x96cm

38"x38"

LOCAL DE USO LOCAL DE USO USAGE	ESPESSURA ESPESOR THICKNESS	CAPA PROTETIVA CAPA PROTECTORA PROTECTIVE LAYER	VARIAÇÃO DE TONALIDADE VARIACION DE TONALIDAD SHADE VARIATION
Doméstico pesado, comercial pesado e industrial geral* Domestic pesado, comercial pesado y industrial en general* Heavy domestic , heavy commercial and general industrial traffic*	3mm 0.12"	0,55mm 0.022"	V4-Moderada V4-Moderada V4-Moderate

*Consulte tabela de 'local de uso' nas páginas 24 e 25.

*Consulte la tabla de 'local de uso' en las páginas 24 e 25.

*See 'usage' chart on pages 24 e 25.



Produto exclusivo para
boutiques e lojas especializadas

New



GRANADA **L3**

8235000

96x96cm - 38"x38"

VELVET

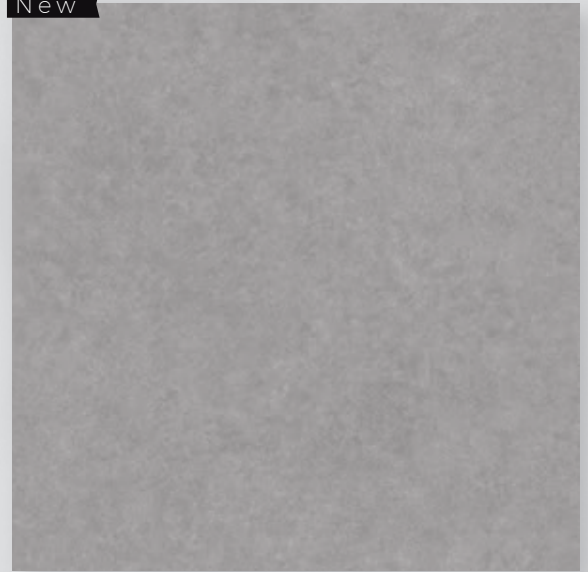

INTERLAGOS **L3**

6235004

96x96cm - 38"x38"

VELVET



Produto exclusivo para
boutiques e lojas especializadas

New



PINHEIROS **L3**

6235003

96x96cm - 38"x38"

VELVET



Produto exclusivo para
boutiques e lojas especializadas

New



ITAIM **L3**

6235005

96x96cm - 38"x38"

VELVET

Essencial Max

Essencial Max | Max Essencial

96x96cm

38"x38"



LOCAL DE USO LOCAL DE USO USAGE	ESPESSURA ESPESOR THICKNESS	CAPA PROTETIVA CAPA PROTECTORA PROTECTIVE LAYER	VARIAÇÃO DE TONALIDADE VARIACION DE TONALIDAD SHADE VARIATION
Doméstico pesado e comercial moderado Domestic pesado y comercial moderado Heavy domestic and moderate commercial*	3mm 0.12"	0,3mm 0.012"	V4-Moderada V4-Moderada V4-Moderate

*Consulte tabela de 'local de uso' nas páginas 24 e 25.

*Consulte la tabla de 'local de uso' en las páginas 24 e 25.

*See 'usage' chart on pages 24 e 25.

Produto exclusivo para boutiques e lojas especializadas

New

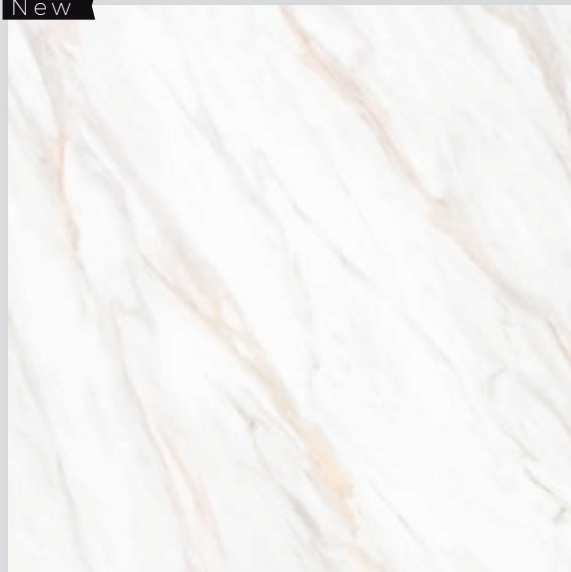

BUTANTÃ **L2**

6233006

96x96cm - 38"x38"

VELVET

Produto exclusivo para boutiques e lojas especializadas

New



PINHEIROS **L2**

6233016

96x96cm - 38"x38"

VELVET

Produto exclusivo para boutiques e lojas especializadas

New

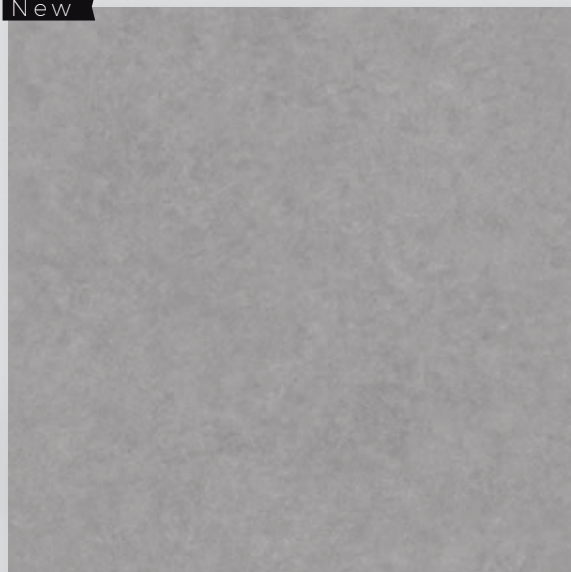

INTERLAGOS **L2**

6233012

96x96cm - 38"x38"

VELVET

Produto exclusivo para boutiques e lojas especializadas

New



ITAIM **L2**

6233013

96x96cm - 38"x38"

VELVET

Los colores de los productos son sólo de referencias y puede haber diferencias con los colores reales de los productos vendidos.
The colors of the products are for references only and there may be differences with the actual colors of the products sold.

Essencial Max

Essencial Max | Max Essential

96x96cm

38"x38"

LOCAL DE USO LOCAL DE USO USAGE	ESPESSURA ESPESOR THICKNESS	CAPA PROTETIVA CAPA PROTECTORA PROTECTIVE LAYER	VARIAÇÃO DE TONALIDADE VARIACION DE TONALIDAD SHADE VARIATION
Doméstico pesado e comercial moderado Domestic pesado y comercial moderado Heavy domestic and moderate commercial*	3mm 0.12"	0,3mm 0.012"	V4-Moderada V4-Moderada V4-Moderate

*Consulte tabela de 'local de uso' nas páginas 24 e 25.

*Consulte la tabla de 'local de uso' en las páginas 24 e 25.

*See 'usage' chart on pages 24 e 25.



 Produto exclusivo para boutiques e lojas especializadas

New



ALPHAVILLE 

6233014
96x96cm - 38"x38"
VELVET

 Produto exclusivo para boutiques e lojas especializadas

New

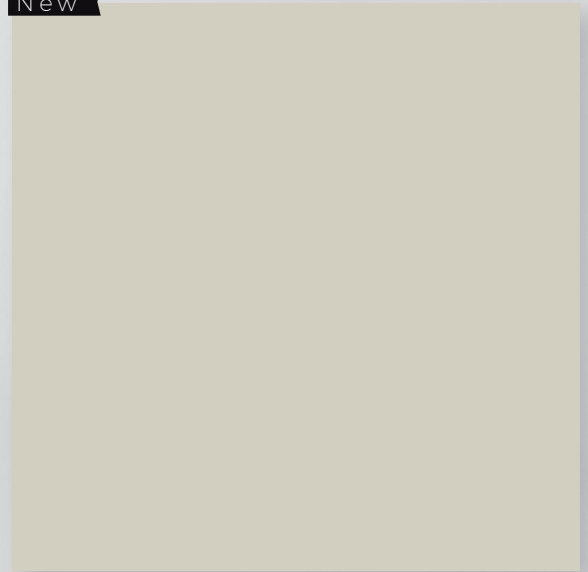

IBIRAPUERA 

6233017
96x96cm - 38"x38"
VELVET

 Produto exclusivo para boutiques e lojas especializadas

New



BROOKLIN 

6233015
96x96cm - 38"x38"
VELVET

 Produto exclusivo para boutiques e lojas especializadas



MORUMBI 

6233005
96x96cm - 38"x38"
VELVET

New



GRANADA L2

8233011
96x96cm - 38"x38"
VELVET



SELENITA L2

8233001
96x96cm - 38"x38"
VELVET



TURMALINA L2

8233000
96x96cm - 38"x38"
VELVET

Essencial Max

Essencial Max | Max Essential

96x96cm

38"x38"



Turmalina 96x96cm | 38" X 38"

Los colores de los productos son sólo de referencias y puede haber diferencias con los colores reales de los productos vendidos.
The colors of the products are for references only and there may be differences with the actual colors of the products sold.

Essencial Leve

Essencial Leve | Light Essential

96x96cm

38"x38"



LOCAL DE USO LOCAL DE USO USAGE	ESPESSURA ESPESOR THICKNESS	CAPA PROTETIVA CAPA PROTECTORA PROTECTIVE LAYER	VARIAÇÃO DE TONALIDADE VARIACIÓN DE TONALIDAD SHADE VARIATION
Residencial* Residencial* Residential*	3mm 0.12"	0,2mm 0.008"	V4-Moderada V4-Moderada V4-Moderate

*Consulte tabela de 'local de uso' nas páginas 24 e 25.

*Consulte la tabla de 'local de uso' en las páginas 24 e 25.

*See 'usage' chart on pages 24 e 25.

 Produto exclusivo para
boutiques e lojas especializadas

New

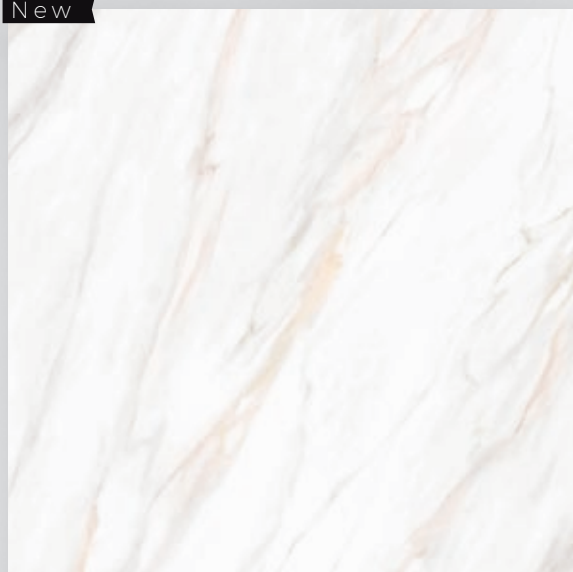

BUTANTÃ 

6232000

96x96cm - 38"x38"

VELVET



SELENITA 

8232003

96x96cm - 38"x38"

VELVET



Selenita 96x96cm | 38"x38"

Natural Ultra

Natural Ultra | Ultra Natural

19X123cm

8"x48"



LOCAL DE USO LOCAL DE USO USAGE	ESPESSURA ESPESOR THICKNESS	CAPA PROTETIVA CAPA PROTECTORA PROTECTIVE LAYER	VARIAÇÃO DE TONALIDADE VARIACIÓN DE TONALIDAD SHADE VARIATION
Doméstico pesado, comercial pesado e industrial geral* Doméstico pesado, comercial pesado y industrial en general* Heavy domestic, heavy commercial and general industrial traffic*	3mm 0.12"	0,55mm 0.022"	V5-Aleatória V5-Aleatória V5-Random

*Consulte tabela de 'local de uso' nas páginas 24 e 25.

*Consulte la tabla de 'local de uso' en las páginas 24 e 25.

*See 'usage' chart on pages 24 e 25.

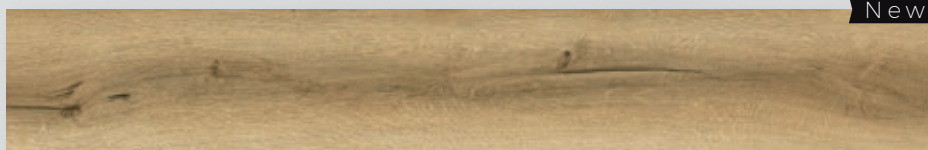

New

L3 CARVALHO
8035001
19x123cm - 8"x48"
RELEVO

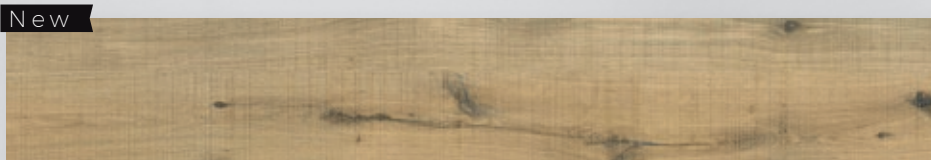

New

L3 COPAÍBA
8035002
19x123cm - 8"x48"
RELEVO

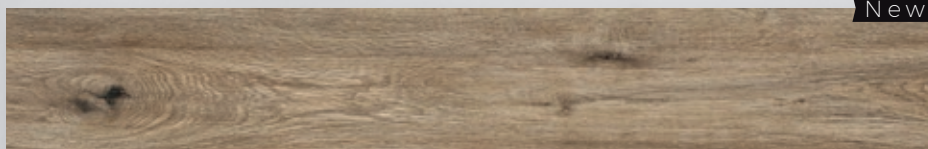

New

L3 NOGUEIRA
8035004
19x123cm - 8"x48"
RELEVO

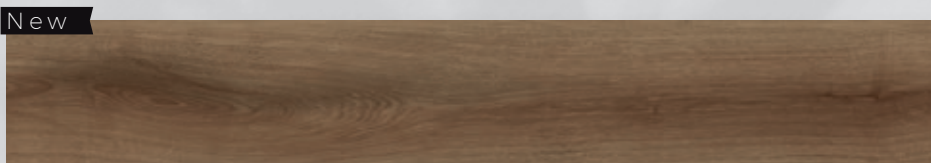

New

L3 OLIVEIRA
8035000
19x123cm - 8"x48"
RELEVO

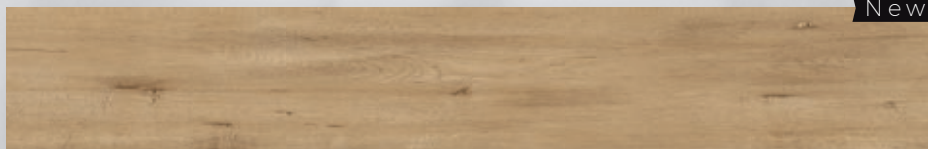

New

L3 TIMBÓ
8035003
19x123cm - 8"x48"
RELEVO

Produto exclusivo para
boutiques e lojas especializadas

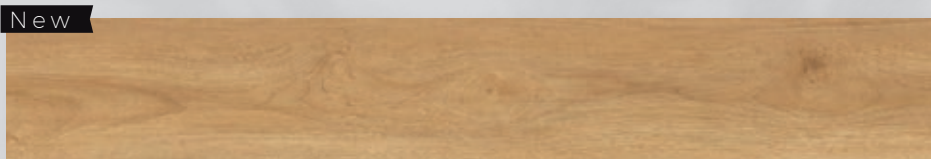

New

L3 PUPUNHA
6035003
19x123cm - 8"x48"
RUSTIC

Natural Ultra

Natural Ultra | Ultra Natural

19X123cm

8"x48"



LOCAL DE USO LOCAL DE USO USAGE	ESPESSURA ESPESOR THICKNESS	CAPA PROTETIVA CAPA PROTECTORA PROTECTIVE LAYER	VARIAÇÃO DE TONALIDADE VARIACIÓN DE TONALIDAD SHADE VARIATION
Doméstico pesado, comercial pesado e industrial geral* Domestic pesado, comercial pesado y industrial en general* Heavy domestic, heavy commercial and general industrial traffic*	3mm 0.12"	0,55mm 0.022"	V5-Aleatória V5-Aleatoria V5-Random

*Consulte tabela de 'local de uso' nas páginas 24 e 25.

*Consulte la tabla de 'local de uso' en las páginas 24 e 25.

*See 'usage' chart on pages 24 e 25.

 Produto exclusivo para
boutiques e lojas especializadas

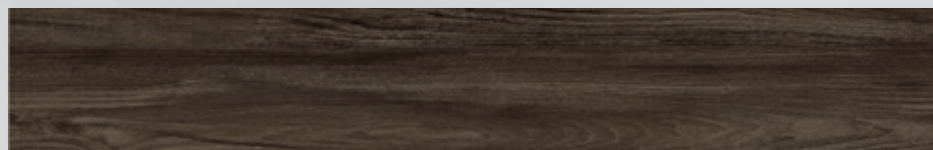

RIO NEGRO 

6035002

19x123cm - 8"x48"

RUSTIC

Produto exclusivo para 
boutiques e lojas especializadas

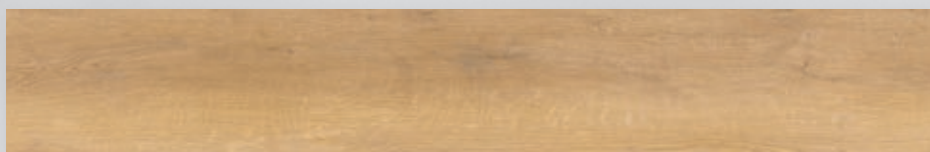

SOLIMÕES 

6035001

19x123cm - 8"x48"

RUSTIC

 Produto exclusivo para
boutiques e lojas especializadas

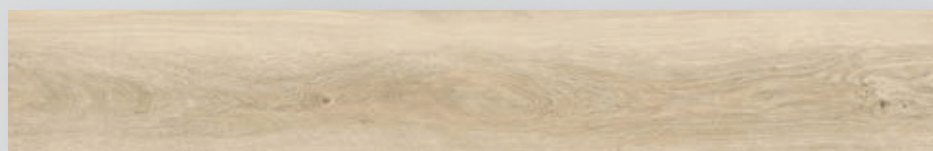

ANDIROBA 

6035000

19x123cm - 8"x48"

RUSTIC



Andiroba 19x123cm | 8"x48"

Natural Max

Natural Max | Max Natural

19X123cm

8"x48"



LOCAL DE USO LOCAL DE USO USAGE	ESPESSURA ESPESOR THICKNESS	CAPA PROTETIVA CAPA PROTECTORA PROTECTIVE LAYER	VARIAÇÃO DE TONALIDADE VARIACIÓN DE TONALIDAD SHADE VARIATION
Doméstico pesado e comercial moderado* Domestic pesado y comercial moderado* Heavy domestic and moderate commercial*	3mm 0.12"	0,3mm 0.012"	V5-Aleatória V5-Aleatória V5-Random

*Consulte tabela de 'local de uso' nas páginas 24 e 25.

*Consulte la tabla de 'local de uso' en las páginas 24 e 25.

*See 'usage' chart on pages 24 e 25.



New

L2 FIGUEIRA
8033015
19x123cm - 8"x48"
RELEVO



New

JACARANDÁ **L2**
8033014
19x123cm - 8"x48"
RELEVO

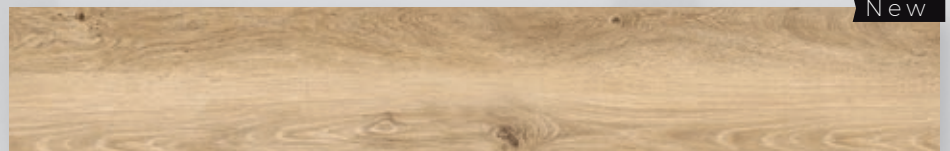

New

L2 PINUS
8033021
19x123cm - 8"x48"
RELEVO

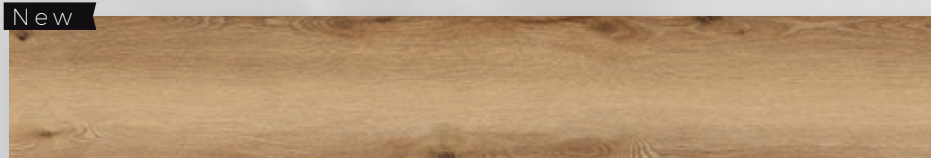

New

ANGELIM **L2**
8033017
19x123cm - 8"x48"
RELEVO



New

L2 CARVALHO
8033012
19x123cm - 8"x48"
RELEVO

Natural Max

Natural Max | Max Natural

19X123cm

8"x48"



LOCAL DE USO LOCAL DE USO USAGE	ESPESSURA ESPESOR THICKNESS	CAPA PROTETIVA CAPA PROTECTORA PROTECTIVE LAYER	VARIAÇÃO DE TONALIDADE VARIACION DE TONALIDAD SHADE VARIATION
Doméstico pesado e comercial moderado* Domestic pesado y comercial moderado* Heavy domestic and moderate commercial*	3mm 0.12"	0,3mm 0.012"	V5-Aleatória V5-Aleatoria V5-Random

*Consulte tabela de 'local de uso' nas páginas 24 e 25.

*Consulte la tabla de 'local de uso' en las páginas 24 e 25.

*See 'usage' chart on pages 24 e 25.

New



COPAÍBA ^{L2}

8033016

19x123cm - 8"x48"

RELEVO

New



^{L2} PITANGUEIRA

8033013

19x123cm - 8"x48"

RELEVO



Pitangueira 19x123cm | 8"x48"

Natural Max

Natural Max | Max Natural

19X123cm

8"x48"

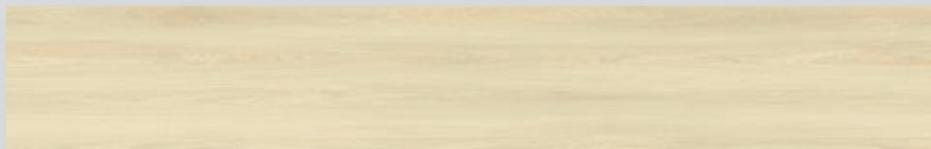

ACÁCIA **L2**

8033018

19x123cm - 8"x48"

RELEVO

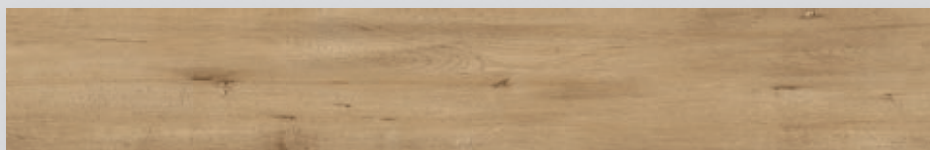

L2 TIMBÓ

8033019

19x123cm - 8"x48"

RELEVO

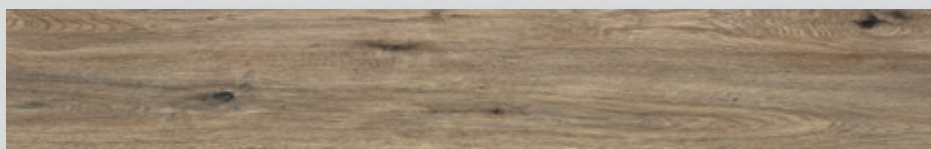

NOGUEIRA **L2**

8033002

19x123cm - 8"x48"

RELEVO

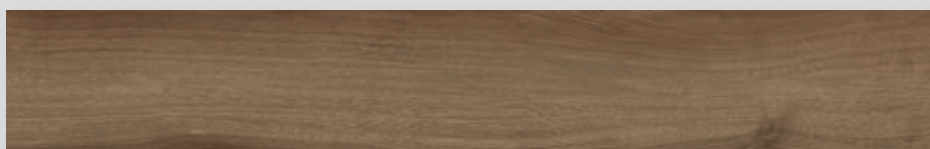

L2 OLIVEIRA

8033001

19x123cm - 8"x48"

RELEVO



Producto exclusivo para
boutiques e lojas especializadas



BAMBU **L2**

6033000

19x123cm - 8"x48"

RUSTIC

Producto exclusivo para
boutiques e lojas especializadas



L2 CIPÓ

6033001

19x123cm - 8"x48"

RUSTIC

Natural Max

Natural Max | Max Natural

19X123cm

8"x48"



LOCAL DE USO LOCAL DE USO USAGE	ESPESSURA ESPESOR THICKNESS	CAPA PROTETIVA CAPA PROTETORA PROTECTIVE LAYER	VARIAÇÃO DE TONALIDADE VARIACIÓN DE TONALIDAD SHADE VARIATION
Doméstico pesado e comercial moderado* Domestic pesado y comercial moderado* Heavy domestic and moderate commercial*	2mm 0.08"	0,3mm 0.012"	V5-Aleatória V5-Aleatória V5-Random

*Consulte tabela de 'local de uso' nas páginas 24 e 25.

*Consulte la tabla de 'local de uso' en las páginas 24 e 25.

*See 'usage' chart on pages 24 e 25.

New



JACARANDÁ

L2

8023013

19x123cm - 8"x48"

RELEVO

New

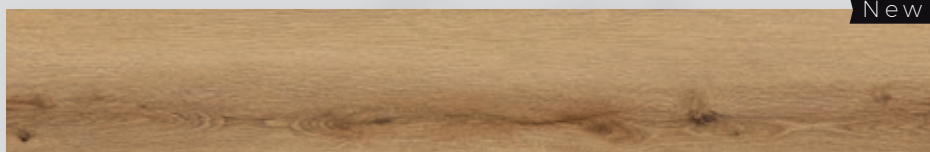

ANGELIM

L2 8023010

19x123cm - 8"x48"

RELEVO

New

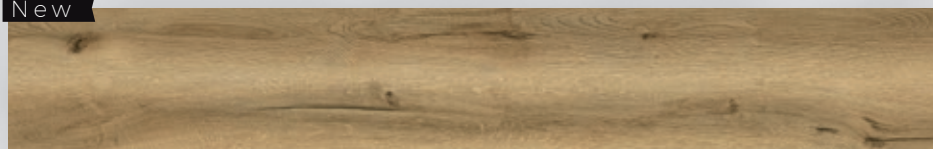

CARVALHO

L2

8023006

19x123cm - 8"x48"

RELEVO

New



PINUS

L2 8023011

19x123cm - 8"x48"

RELEVO

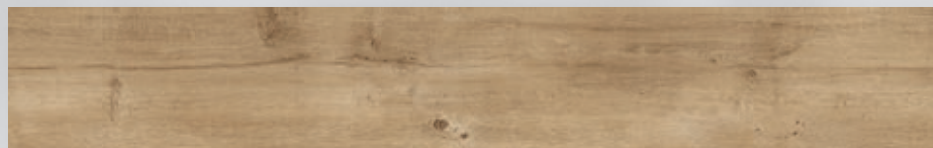

TIMBÓ

L2

8023009

19x123cm - 8"x48"

RELEVO

Natural Max

Natural Max | Max Natural

19X123cm

8"x48"



OLIVEIRA L2

8023001

19x123cm - 8"x48"

RELEVO



L2 NOGUEIRA

8023002

19x123cm - 8"x48"

RELEVO

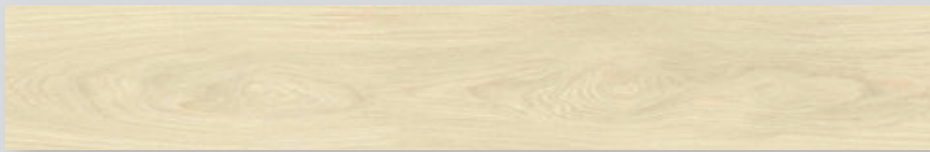

ACÁCIA L2

8023008

19x123cm - 8"x48"

RELEVO



Acácia 19x123cm | 8"x48"

Natural Leve

Natural Leve | Light Natural

19X123cm

8"x48"



LOCAL DE USO LOCAL DE USO USAGE	ESPESSURA ESPESOR THICKNESS	CAPA PROTETIVA CAPA PROTECTORA PROTECTIVE LAYER	VARIAÇÃO DE TONALIDADE VARIACION DE TONALIDAD SHADE VARIATION
Residencial* Residencial* Residential*	2mm 0.08"	0,2mm 0.008"	V5-Aleatória V5-Aleatoria V5-Random

*Consulte tabela de 'local de uso' nas páginas 24 e 25.

*Consulte la tabla de 'local de uso' en las páginas 24 e 25.

*See 'usage' chart on pages 24 e 25.



Produto exclusivo para
boutiques e lojas especializadas

New

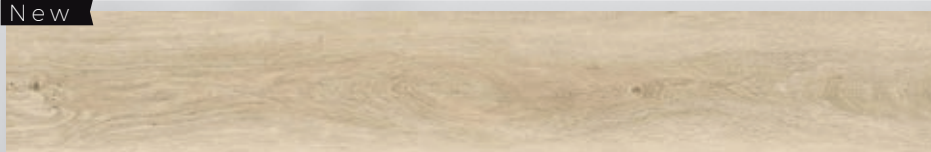

ANDIROBA

6022005

19x123cm - 8"x48"

RUSTIC

Produto exclusivo para
boutiques e lojas especializadas



New

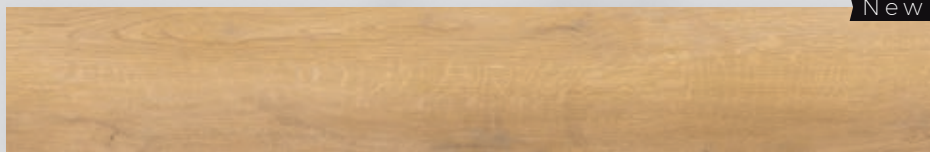

SOLIMÕES

6022004

19x123cm - 8"x48"

RUSTIC

New

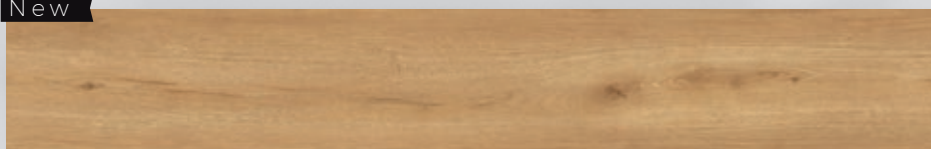

VERNONIA

8022077

19x123cm - 8"x48"

RELEVO

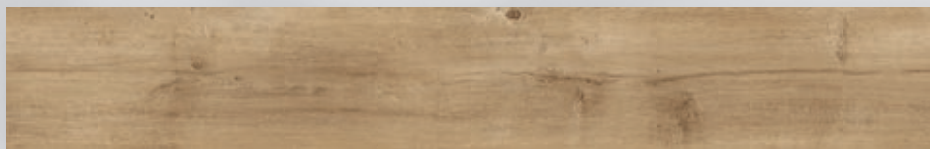

TIMBÓ

8022105

19x123cm - 8"x48"

RELEVO

ACÁCIA

8022104

19x123cm - 8"x48"

RELEVO

Natural Leve

Natural Leve | Light Natural

19X123cm

8"x48"

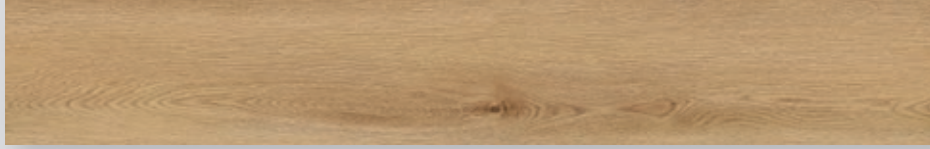

ANGELIM

8022082
19x123cm - 8"x48"
RELEVO



FIGUEIRA

8022081
19x123cm - 8"x48"
RELEVO



COPAÍBA

8022080
19x123cm - 8"x48"
RELEVO

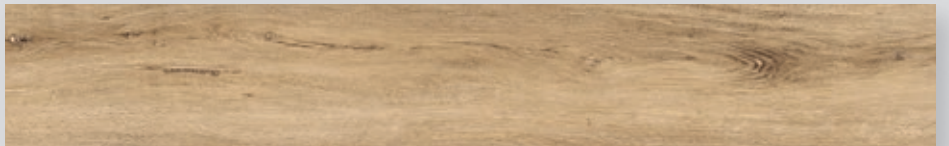

PINUS

8022004
19x123cm - 8"x48"
RELEVO



Natural Leve

Natural Leve | Light Natural

19X123cm

8"x48"



LOCAL DE USO LOCAL DE USO USAGE	ESPESSURA ESPESOR THICKNESS	CAPA PROTETIVA CAPA PROTECTORA PROTECTIVE LAYER	VARIAÇÃO DE TONALIDADE VARIACION DE TONALIDAD SHADE VARIATION
Residencial* Residencial* Residential*	2mm 0.08"	0,2mm 0.008"	V5-Aleatória V5-Aleatoria V5-Random

*Consulte tabela de 'local de uso' nas páginas 24 e 25.

*Consulte la tabla de 'local de uso' en las páginas 24 e 25.

*See 'usage' chart on pages 24 e 25.



JACARANDÁ

8022001

19x123cm - 8"x48"

RELEVO



OLIVEIRA

8022006

19x123cm - 8"x48"

RELEVO



CARVALHO

8022005

19x123cm - 8"x48"

RELEVO

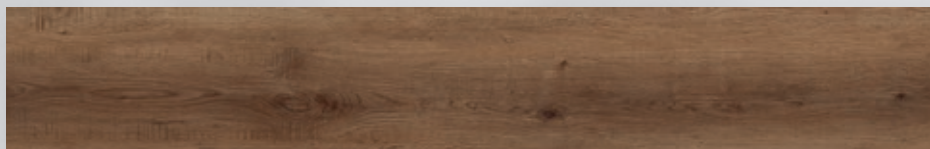

PITANGUEIRA

8022021

19x123cm - 8"x48"

RELEVO

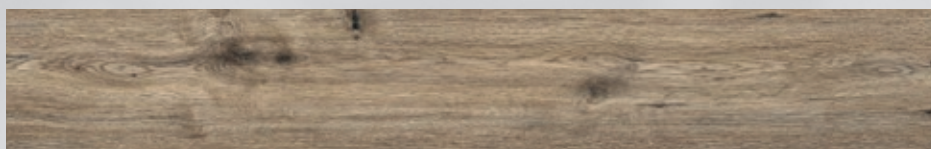

NOGUEIRA

8022008

19x123cm - 8"x48"

RELEVO

Natural Leve

Natural Leve | Light Natural

19X123cm

8"x48"



Produto exclusivo para
boutiques e lojas especializadas

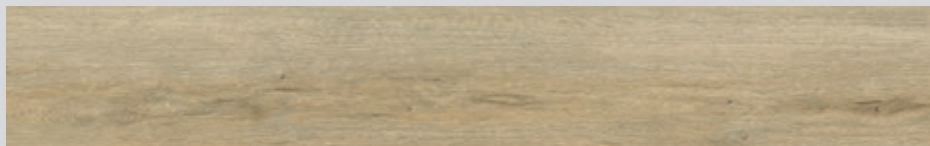

L1 OCA

6022000
19x123cm - 8"x48"
VELVET

Produto exclusivo para
boutiques e lojas especializadas

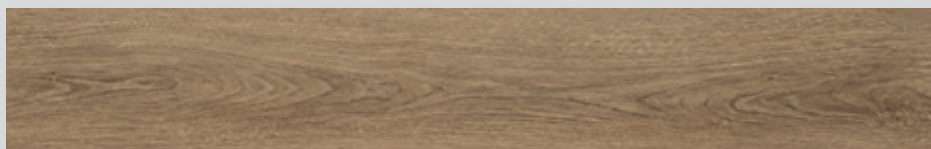

CASTANHA **L1**

6022001
19x123cm - 8"x48"
VELVET

Produto exclusivo para
boutiques e lojas especializadas

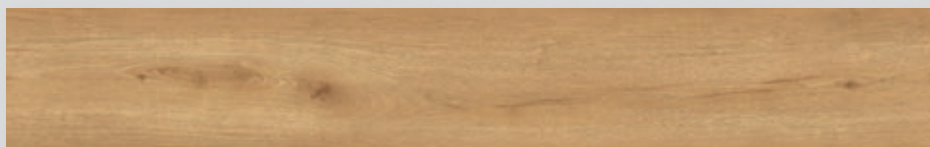

L1 PUPUNHA

6022002
19x123cm - 8"x48"
RUSTIC



Pupunha 19x123cm | 8"x48"

Características técnicas / Características técnicas / Technical characteristics

LOCAL DE USO / LOCAL DE USO / USAGE

L1	Pisos e paredes de dormitórios, estar, hall de entrada e cozinha de ambientes residenciais e quartos de hotéis*. / Pisos y paredes de dormitorios, sala, hall de entrada y cocina para ambientes residenciales y habitaciones de hotel *. / Floors and walls of bedrooms, living room, entrance hall and kitchen for residential environments and hotel rooms*.
L2	Pisos e paredes de dormitórios, estar, jantar, hall de entrada, serviços, corredores e cozinhas residenciais, home office, quartos de hotéis, salas de conferência, reuniões, brinquedoteca, berçários, pré-escola e pequenos escritórios*. / Pisos y paredes de dormitorios, sala, comedor, hall de entrada, servicios, pasillos y cocinas residenciales, home office, cuartos de hotel, salas de conferencias, reuniones, playroom, guarderías, preescolar y pequeñas oficinas*. / Floors and walls of bedrooms, living, dining, entrance hall, services, corridors and residential kitchens, home office, hotel rooms, conference rooms, meetings, playroom, nurseries, preschool and small offices*.
L3	Pisos e paredes de dormitórios, estar, jantar, hall de entrada, serviços, corredores e cozinhas residenciais, home office, quartos de hotéis, salas de conferência, reuniões, brinquedoteca, berçários, pré-escola. Áreas comerciais com tráfego intenso: corredores, lojas de departamento, escolas, saguões de múltiplos usos, grandes escritórios, clínicas, hospitais e hotéis. Áreas industriais onde o trabalho é principalmente de movimentação e/ou com tráfego de veículos: depósitos e montagens eletrônicas*. Ambiente deve ser especificado em comum acordo com o fabricante, conforme norma 14.917-1. / Pisos y paredes de dormitorios, sala, comedor, hall de entrada, servicios, pasillos y cocinas residenciales, home office, cuartos de hotel, salas de conferencias, reuniones, sala de juegos, guarderías, preescolar. Áreas comerciales de alto tráfico: pasillos, tienda por departamentos, escuelas, saguones de variados usos, grandes oficinas, clínicas, hospitales y hoteles. Áreas industriales donde el trabajo es principalmente con movimentación y/o con tráfico de vehículos: almacenes y montajes electrónicos*. El ambiente debe ser especificado junto al fabricante, de acuerdo con la norma 14.917-1. / Floors and walls of bedrooms, living, dining, entrance hall, services, corridors and residential kitchens, home office, hotel rooms, conference rooms, meetings, playroom, nurseries, preschool. Commercial areas with high traffic: corridors, department stores, schools, multipurpose halls, large offices, clinics, hospitals and hotels. Industrial areas where the work is mainly moving and/or with vehicle traffic: warehouses and electronic assemblies*. The environment must be specified in agreement with the manufacturer, according to the standard 14.917-1.
*Não sendo recomendado para áreas externas, garagens e varandas abertas/descobertas. / *No recomendado para áreas al aire libre, garajes y balcones abiertos/descubiertos. / *Not recommended for outdoor areas, garages and open/uncovered balconies.	

Pisos vinílicos (réguas) / Pisos de vinilo (regla) / Vinyl floors (plank)

Linha Línea Line	Natural Ultra Natural Ultra Ultra Natural	Natural Max Natural Max Max Natural	Natural Max Natural Max Max Natural	Natural Leve Natural Leve Light Natural	Natural Leve Natural Leve Light Natural
Local de uso Local de uso / Usage	L3	L2	L2	L1	L1
Tamanho nominal (cm) Tamaño nominal (cm) / Nominal ze (in)	19x123 8x48	19x123 8x48	19x123 8x48	19x123 8x48	24x150 9x59
Dimensão de fabricação (mm) Dimensión de fabricación (mm) Manufacturing dimension (in)	192x1.230 7.56x4.843	192x1.230 7.56x4.843	192x1.230 7.56x4.843	192x1.230 7.56x4.843	240x1.500 9.45x59.06
Espessura (mm) Espesor (mm) / Thickness (in)	3,00 0.12	3,00 0.12	2,00 0.08	2,00 0.08	2,00 0.08
Capa protetiva (mm) Capa protectora (mm) / Protective layer (in)	0,55 0.022	0,30 0.012	0,30 0.012	0,20 0.008	0,20 0.008
Peças por caixa Piezas por caja / Pieces per box	14	14	20	20	18
Peso por caixa (kg) Peso por caja (kg) / Weight per box (lb)	17,00 37.48	17,00 37.48	17,50 38.58	17,50 38.58	23,00 50.71
m² por caixa m² por caja / sqft per box	3,31 35.63	3,31 35.63	4,72 50.80	4,72 50.80	6,48 69.75
Caixas por pallet Cajas por pallet / boxes per pallet	60	60	60	60	40
Peso pallet (kg) Peso pallet (kg) / Weight pallet (lb)	1.045,00 2.303.83	1.045,00 2.303.83	1.075,00 2.369.97	1.075,00 2.369.97	945,00 2.083.37
m² por pallet m² por pallet / sqft per pallet	198,60 2.137.71	198,60 2.137.71	283,20 3.048.34	283,20 3.048.34	259,20 2.790.00
Dimensão por pallet (mm) Dimensión del pallet (mm) Dimensions of pallet (in)	1.250x1.020x670 49.21x40.16x26.38	1.250x1.020x670 49.21x40.16x26.38	1.250x1.020x670 49.21x40.16x26.38	1.250x1.020x670 49.21x40.16x26.38	1.000x1.550x517 39.37x61.02x20.35
Pallets por contêiner Pallets por contenedor Pallets per container	25	25	25	25	28
m² por contêiner m² por contenedor / sqft per container	4.965,00 53.442.82	4.965,00 53.442.82	7.080,00 76.208.49	7.080,00 76.208.49	7.258,00 78.124.46
Instalação Instalación Installation	Colado Pegado Glue down method	Colado Pegado Glue down method	Colado Pegado Glue down method	Colado Pegado Glue down method	Colado Pegado Glue down method
Classe Clase / Class	23 33 42	23 31	23 31	23	23
Intensidade de uso Intensidad de uso Intensity of use	Doméstico pesado, comercial pesado e industrial geral Domestic pesado, comercial pesado y industrial en general Heavy domestic, heavy commercial and general industrial traffic	Doméstico pesado e comercial moderado Domestic pesado y comercial moderado Heavy domestic and moderate commercial	Doméstico pesado e comercial moderado Domestic pesado y comercial moderado Heavy domestic and moderate commercial	Doméstico pesado Domestic pesado Heavy domestic	Doméstico pesado Domestic pesado Heavy domestic

Rodapés de poliestireno / Zócalos de poliestireno / Polystyrene skirtings

Altura (cm) / Altura (cm) / Height (in)	7 / 2.76	10 / 3.94	15 / 5.91	15 / 5.91	20 / 7.87	7 / 2.76	10 / 3.94
Comprimento (cm) / Longitud (cm) / Length (in)	240 / 94.49	240 / 94.49	240 / 94.49	240 / 94.49	240 / 94.49	240 / 94.49	240 / 94.49
Espessura (cm) / Espesor (cm) / Thickness (in)	1,5 / 0.59	1,5 / 0.59	1,5 / 0.59	1,5 / 0.59	1,5 / 0.59	1,0 / 0.39	1,0 / 0.39
Superfície Superficie / Texture	Frisado Ranurado Groove	Frisado Ranurado Groove	Frisado Ranurado Groove	Liso Suave Flat	Frisado Ranurado Groove	Frisado e Liso Ranurado y Suave Groove and flat	Frisado e Liso Ranurado y Suave Groove and flat
Cor Color / Color	Branco Blanco/White	Branco Blanco/White	Branco Blanco/White	Branco Blanco/White	Branco Blanco/White	Branco Blanco/White	Branco Blanco/White
Peso por peça (kg) Peso por pieza (kg) / Weight per piece (lb)	0,92 2.02	1,54 3.40	1,68 3.70	1,68 3.70	2,38 5.24	0,47 1.04	0,87 1.92
Peças por caixa / Piezas por caja / Pieces per box	28	20	14	14	10	30	21
Peso por caixa (kg) / Peso por caja (kg) / Weight per box (lb)	25,76 / 56,79	30,80 / 67,90	23,48 / 51,76	23,42 / 51,63	23,80 / 52,47	14,01 / 30,88	18,20 / 40,12
m por caixa / m por caja / ft. per box	67,20 / 220.47	48,00 / 157.48	33,60 / 110.24	33,60 / 110.24	24,00 / 78.74	72,00 / 236.22	50,40 / 165.35
Caixas por pallet / Cajas por pallet / boxes per pallet	24	24	24	24	24	28	28
Peso por pallet (kg) Peso por pallet (kg) / Weight per pallet (lb)	618,24 1.362,99	739,20 1.629,66	563,40 1.242,08	562,10 1.239,22	596,20 1.314,40	394,80 870,39	509,60 1.123,48
m por pallet m por pallet / ft. per pallet	1.612,80 5.291.34	1.152,00 3.779.53	806,40 2.645.67	806,40 2.645.67	576,00 1.889,77	2.016,00 6.614.17	1.411,20 4.629.92
Dimensão por pallet (mm) Dimensión del pallet (mm) / Dimensions of pallet (in)	2.500x1.000x600 98.42x39.37x23.62	2.500x1.000x600 98.42x39.37x23.62	2.500x1.000x600 98.42x39.37x23.62	2.500x1.000x600 98.42x39.37x23.62	2.450x1.000x987 96.46x39.37x38.85	2.450x1.000x922 96.46x39.37x36.3	2.450x1.000x922 96.46x39.37x36.3
Pallets por contêiner Pallets por contenedor / Pallets per container	8	8	8	8	8	8	8
m por contêiner m por contenedor / ft. per container	12.902,40 42.330.71	9.216,00 30.236.22	6.451,20 21.165.35	6.451,20 21.165.35	4.608,00 15.118.11	16.128,00 52.913.39	11.289,60 37.039.37
Local de uso / Local de uso / Usage	Exclusivo para uso em ambientes internos / Interior exclusivo / Indoor use only						

Pisos vinílicos (placas quadradas) / Pisos de vinilo (platos cuadrados) / Vinyl floors (square plates)

Linha Línea Line	Essencial Ultra Essencial Ultra Ultra Essential	Essencial Max Essencial Max Max Essential	Essencial Leve Essencial Leve Light Essential
Local de uso Local de uso / Usage	L3	L2	L1
Tamanho nominal (cm) Tamaño nominal (cm) / Nominal ze (in)	96x96 38x38	96x96 38x38	96x96 38x38
Dimensão de fabricação (mm) Dimensión de fabricación (mm) Manufacturing dimension (in)	960x960 37.80x37.80	960x960 37.80x37.80	960x960 37.80x37.80
Espessura (mm) Espesor (mm) / Thickness (in)	3,00 0.12	3,00 0.12	3,00 0.12
Capa protetiva (mm) Capa protectora (mm) / Protective layer (in)	0,55 0.022	0,30 0.012	0,20 0.008
Peças por caixa Piezas por caja / Pieces per box	5	5	5
Peso por caixa (kg) Peso por caja (kg) / Weight per box (lb)	23,60 52.03	23,60 52.03	23,60 52.03
m² por caixa m² por caja / sqft per box	4,61 49.62	4,61 49.62	4,61 49.62
Caixas por pallet Cajas por pallet / boxes per pallet	25	25	25
Peso pallet (kg) Peso pallet (kg) / Weight pallet (lb)	615,25 1.356.39	615,25 1.356.39	615,25 1.356.39
m² por pallet m² por pallet / sqft per pallet	115,25 1.240.54	115,25 1.240.54	115,25 1.240.54
Dimensão por pallet (mm) Dimensión del pallet (mm) Dimensions of pallet (in)	1.000x1.000x655 39.37x39.37x25.79	1.000x1.000x655 39.37x39.37x25.79	1.000x1.000x655 39.37x39.37x25.79
Pallets por contêiner Pallets por contenedor Pallets per container	30	30	30
m² por contêiner m² por contenedor / sqft per container	3.458,00 37.221.60	3.458,00 37.221.60	3.458,00 37.221.60
Instalação Instalación Installation	Colado Pegado Glue down method	Colado Pegado Glue down method	Colado Pegado Glue down method
Classe Clase / Class	23 33 42	23 31	23
Intensidade de uso Intensidad de uso Intensity of use	Doméstico pesado, comercial pesado e industrial geral Domestic pesado, comercial pesado y industrial en general Heavy domestic, heavy commercial and general industrial traffic	Doméstico pesado e comercial moderado Domestic pesado y comercial moderado Heavy domestic and moderate commercial	Doméstico pesado Domestic pesado Heavy domestic

Informações de instalação

PISOS VINÍLICOS

Nossos produtos são produzidos no Brasil sob os mais rígidos controles de qualidade e processos industriais. Utilizamos tecnologia de ponta, sempre preocupados com a preservação do meio ambiente. São resistentes, rápidos de instalar, práticos de limpar e de fácil manutenção.

INSTALAÇÃO

Recomendamos a contratação de mão de obra especializada.

Antes de iniciar a instalação, verifique se o produto não apresenta defeitos visíveis e se todas as caixas são do mesmo código, referência e tonalidade. Certifique-se também de que o contrapiso esteja completamente plano, seco, curado, limpo e impermeabilizado, com absorção adequada e firme. Os pisos vinílicos da VinilForte podem ser aplicados em cima de revestimento cerâmico, cimentado ou laje de concreto, mármore e granitos desde que sejam seguidas as recomendações contidas no Manual Técnico disponível no site.

Atente-se à sequência de preparação do contrapiso indicada no manual técnico (impermeabilização, primer, regularização com autonivelante ou massa de preparação e adesivo para LVT).

Antes da instalação, realizar a aclimação do produto. Aclimatar o produto significa deixá-lo "ambientando" na mesma condição local onde será aplicado, pelo período mínimo de 24 horas antes de realizar a instalação dos revestimentos vinílicos, empilhá-lo de forma perfeitamente plana e retirá-lo das caixas. Durante este período a temperatura deverá estar entre 15 °C e 27 °C. Variações mais bruscas de temperatura poderão exigir maiores períodos de aclimação. Em caso de dúvidas, por favor contate nosso SAC. O mesmo procedimento deverá ser adotado em relação ao adesivo acrílico LVT a ser utilizado. Após a instalação aguarde de 2 a 3 dias até a secagem completa do adesivo para realizar a limpeza pesada no seu produto.

INFORMACIONES DE INSTALACIÓN PISOS DE VINILO

Nuestros productos se producen en Brasil bajo los más estrictos controles de calidad y procesos industriales. Utilizamos tecnología de punta, siempre preocupada por preservar el medio ambiente. Son resistentes, rápidos de instalar, prácticos para limpiar y fáciles de mantener.

INSTALACIÓN

Recomendamos contratar mano de obra especializada. Antes de comenzar la instalación, verifique que el producto no tenga defectos visibles y que todas las cajas tengan el mismo código, referencia y tono. También asegúrese de que el contrapiso sea completamente plano, seco, curado, limpio y impermeabilizado, con una absorción adecuada y firme. Los pisos de vinilo de VinilForte se pueden aplicar sobre revestimiento cerámico, losa cementada u hormigón, mármoles y granitos, siempre que se sigan las recomendaciones contenidas en el Manual de instalación disponible en el sitio web. Tenga en cuenta la secuencia de preparación del subsuelo indicada en el manual técnico (impermeabilización, primer, regularización con pasta de nivelación o preparación y adhesivo para LVT). Antes de la instalación, aclimate el producto. Aclimatarse el producto significa dejarlo "aclimatando" en las mismas condiciones que el lugar donde se aplicará, por un período mínimo de 24 horas antes de instalar revestimientos de vinilo, apilarlos perfectamente plano y sacarlo de las cajas. Durante este período la temperatura debe estar entre 15 °C y 27 °C. Las variaciones repentinas de temperatura pueden requerir mayores períodos de aclimatación. En caso de duda, contacte con nuestro SAC. Debería adoptarse el mismo procedimiento en relación con el adhesivo acrílico LVT a utilizar. Después de la instalación, espere de 2 a 3 días para que el adhesivo esté completamente seco para realizar una limpieza intensa en su piso.

MANTENIMIENTO

La limpieza diaria se puede hacer con un paño húmedo y detergente neutro diluido. Es importante no usar exceso de agua al lavar, ya que puede filtrarse entre las juntas y reducir la eficiencia del pegamento, causando burbujas y desprendimientos. Se recomienda usar felpudos en las puertas externas para acceso al ambiente con pisos de vinilos de VinilForte, evitando que la arena de la calle dañe el producto. Los filtros y otras protecciones son adecuados para los pies de los muebles, que, si se arrastran, pueden dañar el piso.

GARANTÍA

El cliente tendrá derecho a una garantía cumpliendo con las siguientes observaciones: Siga estricta y correctamente todas las recomendaciones e información contenidas en el Manual de instalación (disponible en el sitio web de la compañía); El cliente debe conservar la factura de compra del producto, ya que este es el documento que prueba la fecha de compra del piso y el comienzo de su garantía; En el caso de un defecto de fabricación en el piso de vinilo, complete los campos del Certificado de garantía disponibles en el sitio web con los datos de la factura de compra. Luego envíe una copia de la factura y el certificado de garantía al e-mail: sac@carmelofior.com.br; La garantía se refiere exclusivamente a defectos de fabricación de acuerdo con las normas ABNT NBR 14917-1 y 14917-2.

HABLE CON NOSOTROS

Para más instrucciones sobre la instalación, el mantenimiento y la garantía del piso de vinilo contáctenos a través del sitio web: www.vinilforte.com.br o en SAC VinilForte a través del número +55 19 3556-9600.

MANUTENÇÃO

A limpeza do dia a dia poderá ser feita com pano úmido e detergente neutro diluído. É importante não usar água em excesso ao lavar, pois a mesma poderá infiltrar entre as juntas e reduzir a eficiência da cola, provocando bolhas e descolamentos.

É recomendável a utilização de capachos nas portas externas de acesso ao ambiente, evitando que a areia trazida da rua danifique o produto.

Filtros e outras proteções são apropriadas para os pés dos móveis, que ao serem arrastados poderão danificar o piso.

GARANTIA

O cliente terá direito a garantia mediante o cumprimento das seguintes observações:

- Seguir rigorosamente e corretamente todas as recomendações e informações contidas em todos os tópicos do Manual Técnico (disponível no site da empresa);

- O cliente deve manter a nota fiscal de compra do produto, pois este é o documento que comprova a data de compra do piso e início de sua garantia;

- Na hipótese de defeito de fabricação preencher os campos do certificado de garantia disponível no site, com os dados da nota fiscal de compra. Em seguida, enviar cópia da nota fiscal e do certificado de garantia para o e-mail: sac@carmelofior.com.br

- A garantia refere-se exclusivamente a defeitos de fabricação conforme normas ABNT NBR 14917-1 e 14917-2.

FALE CONOSCO

Para mais informações sobre instalação, manutenção e garantia do piso vinílico entre em contato conosco através do site: www.vinilforte.com.br ou no SAC VinilForte através do número (19) 3556-9600.

INFORMATION ABOUT INSTALLATION VINYL FLOORS

Our products are produced in Brazil under the strictest quality controls and industrial processes. We use brand new technology, and always keep the preservation of the environment in mind. Our vinyl tiles are resistant, quick to install, practical to clean and easy to maintain.

INSTALLATION

We recommend hiring specialized labor. Before starting the installation, check if the product has any visible defects and that all boxes are of the same code, reference and tone. Also make sure that the substrate to be completely flat, dry, cured, clean and waterproofed, with adequate absorption and firm. VinilForte's vinyl tiles can be applied over ceramic tiles, cement or concrete slab, marble and granite, once that the recommendations of the installation manual available on our website are followed. Pay attention to the subfloor preparation sequence indicated in the technical manual (waterproofing, primer, leveling with self-leveling or preparation paste and adhesive for LVT). Before installation, acclimatize the product. To acclimatize the product means to leave it "acclimatizing" in the same local condition where it will be applied, for a minimum period of 24 hours before installing vinyl coverings, stacking it perfectly flat and removing it from the boxes. During this period the temperature should be between 15 °C / 59 °F and 27 °C / 81 °F. Sudden variations in temperature may require longer periods of acclimatization. In case of doubt, please contact our Customer Service. The same procedure must be adopted in relation to the acrylic adhesive LVT to be used. After installation, wait for 2 to 3 days for the adhesive to dry completely before perform heavy cleaning.

MAINTENANCE

Day-to-day cleaning can be done with a damp cloth and diluted neutral detergent. It is important not to use excessive water when cleaning, as it can seep between the gaps and reduce the efficiency of the glue, causing bubbles and detachments. The recommendation is to use of doormats at the external doors to access the environment with VinilForte vinyl tiles, preventing any sand brought from the street to damage the product. Felts and other protections are suitable for furniture feet, which, when dragged, may damage your product.

WARRANTY

The customer will be entitled to a guarantee by complying with the following observations: Follow strictly and correctly all recommendations and information contained in the Installation Manual (available at the company's website); The customer must keep the product purchase invoice, as this is the document that proves the date of purchase of the floor and the beginning of its warranty; In case of a manufacturing defect in the vinyl tile, fill in the fields of the Warranty Certificate available on the website with the purchase invoice data. Then send a copy of the invoice and the guarantee certificate to the email: sac@carmelofior.com.br; The warranty refers exclusively to manufacturing defects according to ABNT NBR 14917-1 and 14917-2 standards.

CONTACT US

For more instructions on installation, maintenance and warranty contact us through the website: www.vinilforte.com.br or at SAC VinilForte through the number + 55 19 3556-9600.



Consulte nosso manual técnico.
Consulte nuestro manual técnico.
See our technical manual.

 **VinilForte**
PISOS VINÍLICOS E RODAPÉS

CARMELO FIOR **35**





VinilForte

PISOS VINÍLICOS E RODAPÉS

Avenida João Pinto,1070
Distrito Industrial I José Marangoni
Mogi Mirim / SP - Brasil
CEP 13.803-360

www.vinilforte.com.br

   VinilForte